

UNI-T®



UTi165B

红外热成像仪

Professional Thermal Imager

P/N:110401110261X

UTi165B
红外热成像仪使用说明书
(5p-27p)

UTi165B
Professional Thermal Imager
User Manual
(29p-51p)

序言

尊敬的用户：

您好！感谢您选购全新的UTi165B热成像仪，为了正确使用本产品，请您在使用之前仔细阅读本说明书全文，特别是有关“安全注意事项”的部分。

如果您已经阅读完本说明书全文，建议您将此说明书妥善保管，与热成像仪一同放置或者放在您随时可以查阅的地方，以便在将来的使用过程中查阅。

有限担保和有限责任

公司担保本产品自购买之日起一年内，在材料和工艺上均无任何缺陷。本担保不适用于由于意外、疏忽、误用、改装、污染及非正常操作或处理引起的损坏。经销商无权以公司的名义给予其它任何担保。如在保修期内需要维修服务，请与您就近的授权服务中心联系，获得产品退还授权信息；然后将产品寄至该服务中心，并附上产品问题描述。

本项担保是您能获得的唯一补偿。除此以外，公司不提供任何明示或隐含的担保，例如适用于某一特殊目的的隐含担保。同时，公司不对基于任何原因或推测而导致的任何特殊、间接、附带或继起的损坏或损失负责，由于某些州或国家不允许对默示担保及附带或继起的损坏加以限制，故上述的责任限制与规定或许对您不适用。

产品使用指南

为保证正确使用本产品，请在使用之前，仔细阅读此指南：

1. 请在室内无风环境使用；
2. 当转换到新的环境下使用，请先将产品开机，放置10至15分钟后再测量；
3. 测试的环境温度要稳定，不能在风扇、空调的出风口等气流较大的地方测量；
4. 当测量对象来自于测量环境温度差异比较大的地方，需要在测试环境内停留10~30分钟后进行测量；
5. 本产品具有自我校准功能，如果读数有快速跳动，请等30秒左右，待读数稳定后再做测量；
6. 请勿在测量极高温或极低温的物体温度后，立刻开始测量其它被测对象，请放置10分钟后进行测量；
7. 不能在阳光强烈的地方使用；
8. 不能在电磁干扰场所使用。

目录

1. 性能指标	8
2. 构造	10
3. 显示说明	11
4. 开关机	12
5. 测量	12
6. 色板	10
7. 点测温	14
8. 图像模式	15
9. 设定	16
9.1 语言选择	16
9.2 日期时间	17
9.3 温度单位	17
9.4 高低温警告	18
9.5 测量参数	18
9.6 显示亮度	19
9.7 自动关机	19
9.8 USB模式	20
9.9 自动保存	20
9.10 系统设定	21
10. 图像浏览	23
11. 图像拍摄	24
12. 照明	24
13. USB通信及图像投屏	24
14. SD卡	25
15. 充电	25
16. 保养	25
17. 安全须知	25
18. 使用须知	25
19. 附录	26

1. 性能指标

传感器	非制冷焦平面
测温范围	-10°C~400°C
分辨率	0.1°C
精度	0°C以上目标温度, +/-2°C或+/-2%, 常温25°C环境
测温响应时间	≤500ms
热成像像素	19200 (160*120)
像素大小	12 μm
色板	铁红, 彩虹, 白热, 黑热, 红热, 熔岩, 高对比彩虹
红外光谱带宽	8~14μm
视场角 (FOV)	56° (H) *42° (V)
瞬时视场角 (IFOV)	6mrad
热成像灵敏度	<50mK
帧速率	<9Hz
测温显示	中心点测温和高温追踪 (默认高温追踪)
图像格式	BMP
按键	10个按键 (开机键、拍照键、返回键、左右上下导航键、SET键、图片浏览键、LED照明开关键)
图像模式	热成像、数码相机 (可见光)、融合
测温点	除中心点, 可以添加3个测温点
可见光	有
可见光分辨率	640*480

混合设定	0% (全可见光), 25%, 50%, 75%, 100% (全热成像)
PC分析软件 (PC)	有
实时图像传输	有 (PC软件实时图像投屏)
数据通讯	Type-C USB
产品尺寸 (LxWxH)	236mm*75.5mm*86mm
显示类型	2.8" TFT LCD
显示分辨率	320*240
电池	Li-ion 3.6V/5000mAh 26650 单节
自动关机	可选 (5min 10min 30min) 默认30min自动关机
使用时间	不低于6小时
充电时间	不超过5小时
充电电压/电流	5V/2A
图像存储	Micro SD卡
运输环境、存储环境	-20°C~60°C (-4°F~140°F) <85%RH (非冷凝)
工作温度	0°C~50°C (32°F~122°F)
工作湿度	10%~95% RH (非冷凝)
海拔	不超过2000米
配件	说明书, Type-C USB线, 16GB TF卡

2. 构造

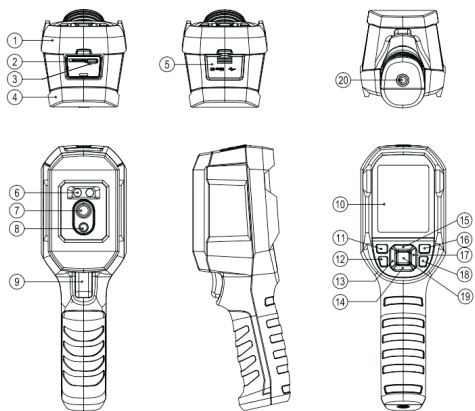

项目	说明	项目	说明
1	上壳	11	开机键
2	SD卡槽	12	照明灯键
3	USB Type-C接口	13	左键
4	下壳	14	下键
5	接口防护盖	15	上键
6	照明灯	16	照片浏览键
7	红外热像窗口	17	右键
8	可见光摄像窗口	18	返回键
9	拍照扳机键	19	SET键
10	液晶显示屏	20	支架固定螺孔

3. 显示说明

屏幕尺寸：2.8"

显示器分辨率：320(垂直) x 240(水平)

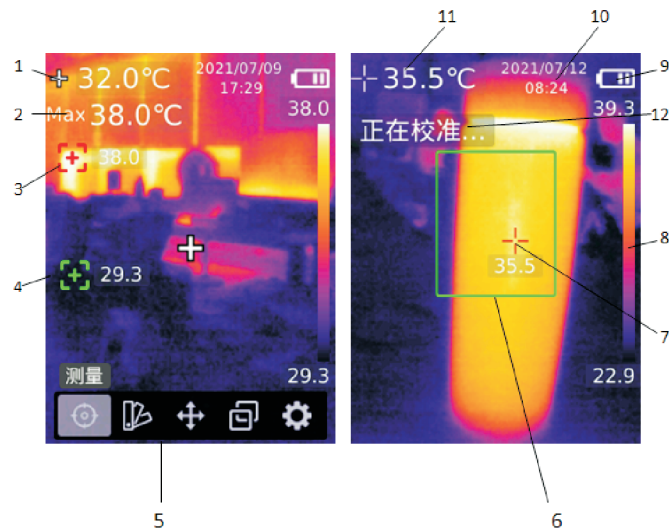

项目	说明	项目	说明
1	当前中心温度	7	重点区域温度最大点
2	当前自动追踪温度最大点温度	8	温度条
3	当前自动追踪温度最大点	9	当前电池电量标示
4	当前自动追踪温度最小点	10	当前时间
5	主菜单栏	11	当前重点区域温度最大点温度
6	重点区域测温(ROI)	12	当前正在校准中

4. 开关机

长按开机键3秒，热像仪开机。长时间没使用或测量环境改变后需要开机10~15分钟后才进行温度测量；长按开机键3秒，热像仪关机。

注意：热像仪启动关机程序后，需要经历5~6秒。请尽量避免连续反复开关机，以免对热像仪造成损害。

5. 测量

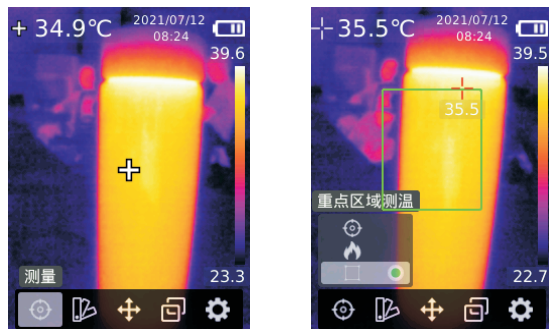

在热成像主测试页面，按SET键调出主菜单栏，按左/右按键选择测量选项 ，短按SET键进入测量选择菜单，按上/下按键选择测量中心点、高低温点或重点区域测温 (ROI)，短按SET键选择打开或关闭测量中心点、高低温点或重点区域测温 (ROI)，短按返回键返回主菜单栏及热成像页面。

6. 色板

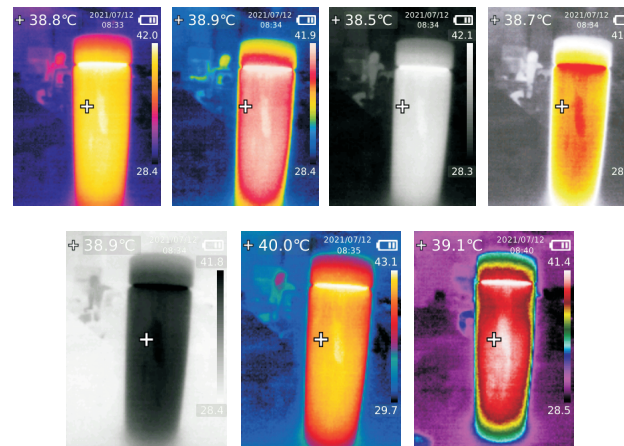
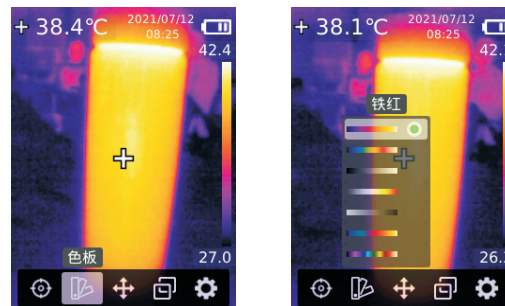

在热成像主测试页面，按SET键调出主菜单栏，按左/右按键选择色板配置选项 ，短按SET键进入色板选择菜单，按上/下按键选择不同色板，短按SET键应用当前色板，短按返回键返回主菜单栏及热成像页面。

7. 点测温

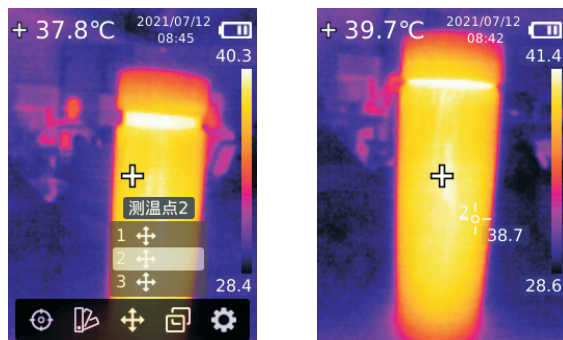

在热成像主测试页面，按SET键调出主菜单栏，按左/右按键选择点测温选项 \oplus ，短按SET键进入点测温菜单，按上/下按键选择打开或关闭不同测温点，选择打开当前测温点后自动进入热成像主测试页面，按左/右/上/下按键移动测温点到感兴趣区域，短按SET键应用当前，并读取当前点温度；如果选择关闭当前测温点，短按SET键关闭，短按返回键返回主菜单栏。

8. 图像模式

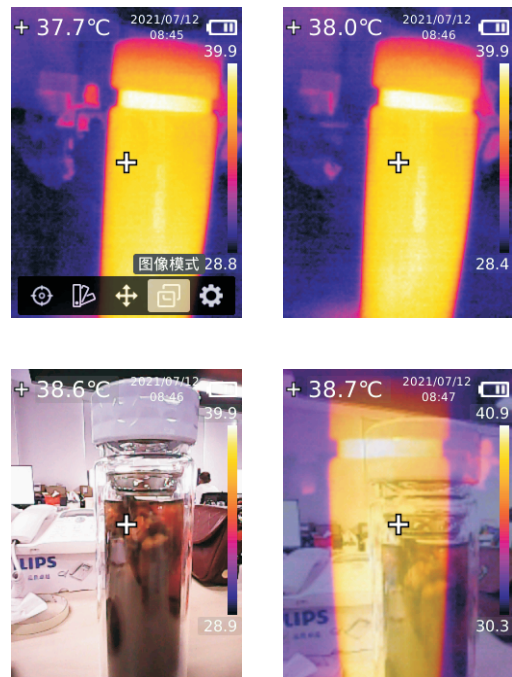

在热成像主测试页面，按SET键调出主菜单栏，按左/右按键选择图像模式配置选项 📷 ，短按SET键进入图像模式选择菜单，按上/下按键选择不同图像模式，图像模式有热成像、数码相机(可见光)、融合，选择后短按SET键应用当前模式，短按返回键返回主菜单栏及热成像页面；在融合成像模式下，返回成像主页面后，可以通过按左/右按键选择不同融合比例，融合比例有：0%(全可见光)，25%，50%，75%，100%(全热成像)。

9. 设定

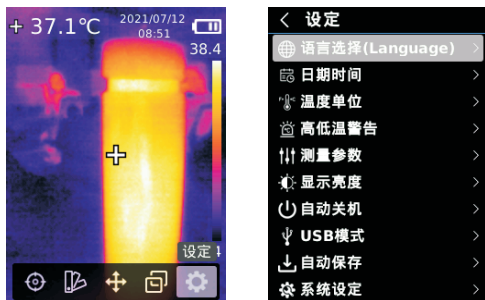

在热成像主测试页面，按SET键调出主菜单栏，按左/右键选择设定选项，短按SET键进入设定二级菜单，按上/下按键选择不同设定选项，短按SET键进入相对应的设定选项并进行参数配置，短按返回键返回上级菜单。

9.1 语言选择

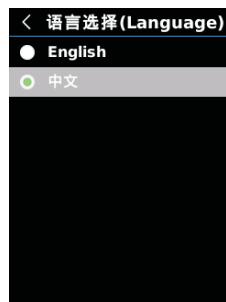

进入设定菜单后，按上/下按键选择语言选择选项，短按SET键进入语言选择，可以按上/下按键选择中文或English，短按SET键保存当前设置，设置完毕后短按返回键返回上级菜单。

9.2 日期时间



进入设定菜单后，按上/下按键选择日期时间设置选项，短按SET键进入日期时间设置，通过左/右键选择不同的时间节点和时间格式，短按SET键选定时间节点，按上/下按键可以进行加减时间，短按SET键/返回键保存设置，设置完毕后短按返回键返回上级菜单。

9.3. 温度单位



进入设定菜单后，按上/下按键选择温度单位设置选项，短按SET键进入温度单位设置，按上/下按键选择不同的温度单位，短按SET键保存设置值，设置完毕后短按返回键返回上级菜单。

9.4 高低温警告



进入设定菜单后，按上/下按键选择高低温警告设置选项，短按SET键进入高低温警告设置，按上/下按键选择不同的设置项，可以分别打开或关闭高低温警告并设置温度值，选择温度值，短按SET键进入设置值，按上/下按键可以进行加减数值，设置完毕后短按SET键/返回键保存设置值，按返回键返回上级菜单。打开警告后，当高温超出设置值时，主页面会弹出红色正三角的警告，LED闪烁；当低温超出设置值时，主页面会弹出绿色倒三角的警告。

9.5 测量参数



进入设定菜单后，按上/下按键选择测量参数设置选项，短按SET键进入测量参数设置，短按SET键进入发射率设置，按上/下按键可以加减数值，设置完毕后按SET键/返回键保存参数，短按返回键返回上级菜单。

备注：常用物体的发射率请参照附录的常用发射率表

9.6 显示亮度



进入设定菜单后，按上/下按键选择显示亮度设置选项，短按SET键进入显示亮度设置，按上/下按键选择不同的显示亮度等级，短按SET键选择并保存设置，短按返回键返回上级菜单。

9.7 自动关机



进入设定菜单后，按上/下按键选择自动关机设置选项，短按SET键进入自动关机设置，按上/下按键选择不同的自动关机时间或关闭自动关机，短按SET键选择并保存设置，短按返回键返回上级菜单。自动关机时间有5分钟、10分钟、30分钟、关闭可选。

9.8 USB模式



进入设定菜单后，按上/下按键选择USB模式设置选项，短按SET键进入USB模式设置，按上/下按键选择不同的USB模式，短按SET键选择并保存设置，短按返回键返回上级菜单。

U盘模式：连接PC后可以在PC端浏览图片和分析数据；

USB相机模式：连接PC后可以实现实时图像投屏功能。

9.9 自动保存



进入设定菜单后，按上/下按键选择自动保存设置选项，短按SET键进入图像自动保存设置，按上/下按键选择是否打开自动保存功能，短按SET键选择并保存设置，短按返回键返回上级菜单。

注意：在保存、浏览图片的过程中，请勿拔插SD卡。建议保存图片张数不超过1000张，以免影响机器反应速度。当图片张数超过1000张时，请及时清理SD卡。

9.10 系统设定



进入设定菜单后，按上/下键选择系统设定选项，短按SET键进入系统设定菜单，按上/下键选择相应的系统设定功能，短按SET键进入下级菜单，短按返回键返回上级菜单。

9.10.1 设备信息



在系统设定中，按上/下按键选择设备信息选项，短按SET键进入设备信息查看，短按返回键返回上级菜单。备注：容量为当前所使用的SD卡的储存容量。

9.10.2 恢复出厂设置



在系统设定中，按上/下按键选择恢复出厂设置选项，短按SET键进入，按上/下按键选择是否恢复出厂设置，短按SET键确定，短按返回键返回上级菜单。

注意：在恢复出厂设置过程中，请勿强制进行其他操作，以免程序错误。

9.10.3 格式化SD卡



在系统设定中，按上/下按键选择格式化SD卡选项，短按SET键进入，按上/下按键选择是否格式化SD卡，短按SET键确定，短按返回键返回上级菜单。

注意：在格式化SD卡过程中，请勿强制拔出SD卡或进行其他操作，以免程序错误。

10. 图像浏览

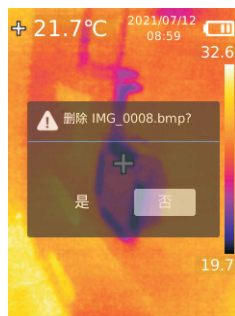
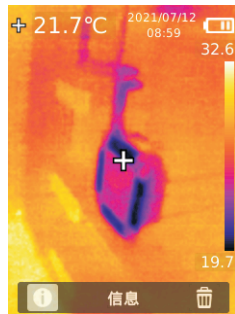
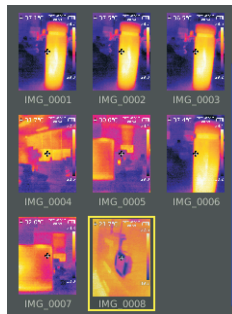

短按照片浏览按键进入照片浏览界面，通过上/下/左/右按键可以选择不同照片，短按SET键进入全屏浏览。在全屏浏览模式下，点SET键进入图像信息浏览及图像删除，点左/右按键可以切换其他照片。

注意：浏览图像过程中，不能插拔SD卡，以防出错。

11. 图像拍摄

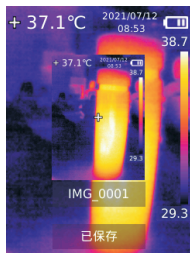

短按拍照板机按键，进行图片拍照；手动保存模式下再次按拍照板机按键即可保存图像，或者通过左/右按键选择是否保存图像，并按SET键确认或取消，也可以按返回键返回，来取消本次拍照。自动保存模式下，图像会自动保存到SD卡。

备注：只有安装了SD卡后，才能保存图像。

12. 照明

长按照明按键3秒打开或关闭LED照明灯；在把高温警告打开后，当所检测的温度超过所设置的温度范围时，LED照明灯闪烁警告，直至警告解除。

注意：请不要在照明灯打开的情况正对着人或动物眼睛，避免造成伤害。

13. USB通信及图像投屏

1. 请参照下载指南下载UTi Thermal Analyzer上位机软件及实时图像投屏上位机软件并完成安装。
2. USB模式设置为U盘模式后，将USB数据线与电脑连接，通过上位机软件可以浏览图片和分析数据。
3. USB模式设置为USB相机后，将USB数据线与电脑连接，通过图像投屏上位机软件，可以实现实时图像投屏功能。
4. 关于上位机软件的使用方法，你可以从操作界面的帮助选项中调取《软件用户手册》做参考。

备注：电脑投屏的过程中，请不要拔掉USB线；使用完毕后，请先关掉投屏软件，然后再拔掉USB线。

14. SD卡

本设备支持Micro SD卡(TF卡)存储图像，为了避免图像数据过大影响设备运行速度，请定期拷贝备份数据，并及时清理卡内数据。为了避免热拔插造成SD卡数据异常，请不要反复拔插SD卡，尽量在关机状态下拔插SD卡。

15. 充电

本设备支持5V/1A或5V/2A电源适配器充电，请使用具有安规认证的电源适配器进行充电。

注意：在充电过程中，请勿轻易按关机键关机，如若需要关机重启，请拔出Type-C电源线，断开电源再重启设备。

16. 保养

用湿布或弱碱性肥皂液清洗结构外壳，不要使用研磨剂、异丙醇或溶剂清洁仪器外壳镜头/窗口。

17. 安全须知

为了保证测量结果准确，请仔细阅读使用说明。请务必按照说明书使用本产品，否则造成产品损坏后将不进行免费保修。请不要在易燃易爆、蒸汽周围、潮湿或腐蚀性环境下使用本仪器。请不要在仪器损坏、摔落或修正后的情况下继续使用，以免造成错误的测试结果。

18. 使用须知

请参考辐射系数信息获取实际温度，否则会导致测得的温度不准确。由于产品功耗发热比较大，会引起机体内部温度升高，为了保证产品精度，长时间关机状态再开机使用时，建议开机预热10至15分钟后再进行测量。由于充电会引起机体内温度升高，从而影响温度测量精度，因此，建议在对本产品充电时不要进行温度测量。

因传感器固有的温度漂移特性，偶尔会测温不准，传感器会自动打快门并进行温度校正，为了产品测量精度需温度稳定后读数。

19. 附录

常用发射率

材质	发射率	材质	发射率
木	0.85	黑纸	0.86
水	0.96	聚碳酸	0.8
砖	0.75	混凝土	0.97
不锈钢	0.14	氧化铜	0.78
胶带	0.96	铸铁	0.81
铝板	0.09	锈	0.8
铜板	0.06	石膏	0.75
黑铝	0.95	油漆	0.9
人体皮肤	0.98	橡胶	0.95
沥青	0.96	土壤	0.93
PVC塑料	0.93		

备注:

本说明书可以在优利德官网下载电子档，下载方法请参考指南。

优利德®

优利德科技(中国)股份有限公司

地址：广东省东莞市松山湖园区工业北一路6号

电话：(86-769) 8572 3888

邮编：523 808

<http://www.uni-trend.com.cn>



Preface

Thank you for purchasing the new UTi165B thermal imager. In order to use this product safely and correctly, please read this manual thoroughly, especially the *Safety Instructions* part.

After reading this manual, it is recommended to keep the manual at an easily accessible place, preferably close to the device, for future reference.

Limited Warranty and Liability

Uni-Trend guarantees that the product is free from any defect in material and workmanship within one year from the purchase date. This warranty does not apply to damage caused by accident, negligence, misuse, modification, contamination or improper handling. The dealer shall not be entitled to give any other warranty on behalf of Uni-Trend. If you need warranty service within the warranty period, please contact your seller directly.

Uni-Trend will not be responsible for any special, indirect, incidental or subsequent damage or loss caused by using this device.

Table of Contents

1. Safety Instructions -----	31
2. Structure -----	32
3. Display -----	33
4. Power On/Off -----	34
5. Menu Introduction -----	34
6. Operating Instructions -----	45
7. Specifications -----	48
8. Maintenance -----	50
9. Common Emissivity -----	50

1. Safety Instructions

To ensure proper use of this product, please read the instructions carefully before using.

- Please use the product indoors without wind.
- When changing to a new environment, please turn on the product and leave it for 10 to 15 minutes before measuring.
- The ambient temperature for measuring must be stable. Do not measure in places with large airflow such as fans and air outlets.
- When the measured object comes from a place with a large temperature difference from the measurement environment, keep it in the measurement environment for 10 to 30 minutes before measuring.
- The product has a self-calibration function. If the reading jumps quickly, please read the temperature after it gets steady.
- After measuring extremely high or low temperature objects, please leave the product for 10 minutes before next use.
- Do not use the product in places with strong sunlight or electromagnetic interference.
- Please do not use the product in flammable, explosive, steamy, wet or corrosive environments.
- Please stop using the product if it is damaged or modified to avoid inaccurate measurement results.
- Please use the correct emissivity to obtain accurate temperature readouts.
- To ensure accuracy of the product, please warm it up for 10 to 15 minutes before measuring if it has not been used for a long time.
- When being charged, the internal temperature of the product rises, which will lead to inaccurate temperature measurement. So, it is not recommended to take measurements during or right after charging the product.

2. Structure

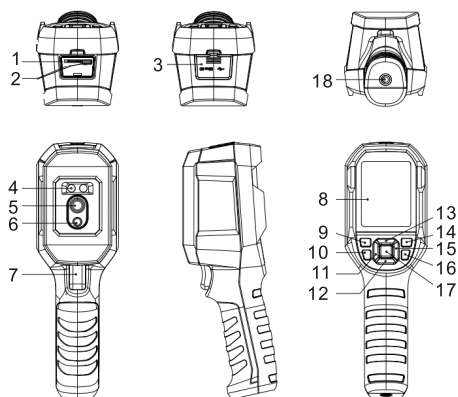

Item	Description	Item	Description
1	SD card slot	10	Flashlight button
2	USB (Type-C) interface	11	Left button
3	Interface cover	12	Down button
4	LED light	13	Up button
5	Infrared camera lens	14	Replay button
6	Visual light camera lens	15	Right button
7	Trigger	16	Back button
8	LCD display	17	SET button
9	Power button	18	Tripod mounting hole

3. Display

Display size: 2.8"

Display resolution: 320 (vertical) x 240 (horizontal) pixels

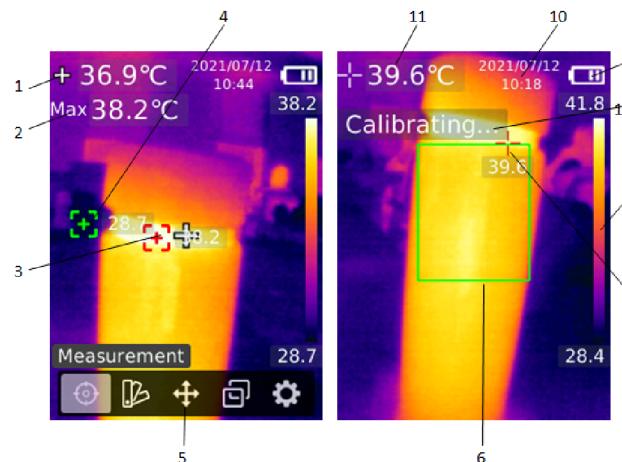

Item	Description	Item	Description
1	Center point temperature	7	Maximum temperature point in ROI
2	Maximum temperature	8	Temperature bar
3	Maximum temperature point	9	Battery status
4	Minimum temperature point	10	Date and time
5	Main menu	11	Maximum temperature in ROI
6	Region of interest (ROI)	12	Calibrating...

4. Power On/Off

Press and hold the power button for 3 seconds to turn on/off the product.

Note: After the product starts the shutdown procedure, it takes 5 to 6 seconds. Please try to avoid turning on and off the product continuously to avoid damage.

5. Menu Introduction

5.1 Measurement

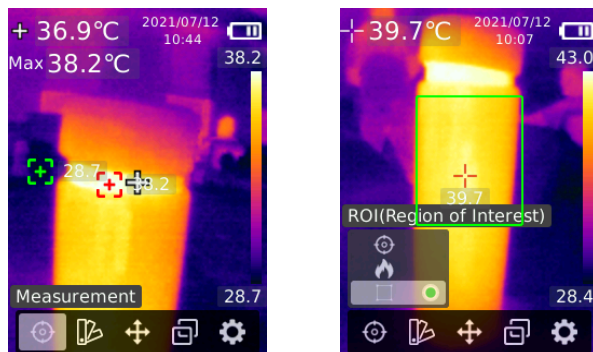

1. Press the SET button to open the main menu.
2. Press the left/right button to select the  option.
3. Press the SET button to enter the Measurement menu.
4. Press the up/down button to select Center Spot (center point measurement), HiLo Spot (maximum and minimum temperature measurement) or ROI.
5. Press the SET button to turn on/off Center Spot, HiLo Spot or ROI.
6. Press the back button to exit.

5.2 Palette



1. Press the SET button to open the main menu.
2. Press the left/right button to select the  option.
3. Press the SET button to enter the Palette menu.
4. Press the up/down button to select the desired palette.
5. Press the SET button to apply the palette.
6. Press the back button to exit.

5.3 Point Temperature

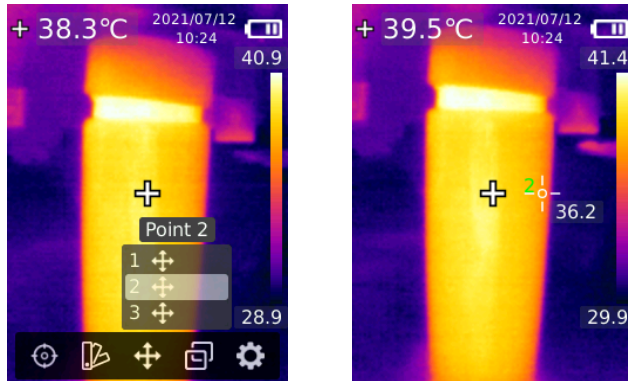

1. Press the SET button to open the main menu.
2. Press the left/right button to select the **+** option.
3. Press the SET button to enter the Point Temperature menu.
4. Press the up/down button to select the desired point.
 - A. Press the SET button to turn on the point and enter the thermal imaging page.
Press the left/right/up/down button to move the point.
Press the SET button to confirm and read the temperature of the current point.
 - B. Press the SET button to turn off the point.
Press the back button to exit.

5.4 Image Mode

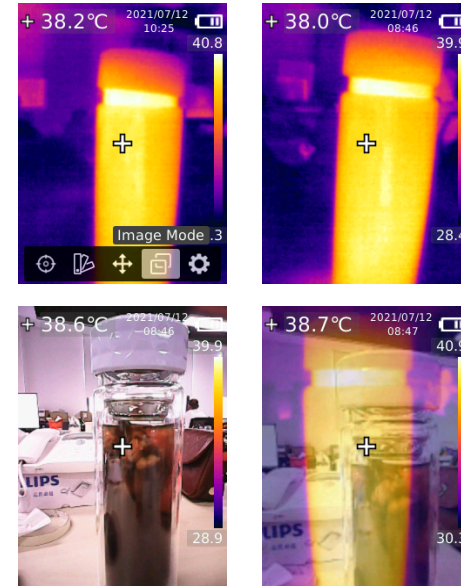

1. Press the SET button to open the main menu.
2. Press the left/right button to select the **+** option.
3. Press the SET button to enter the Image Mode menu.
4. Press the up/down button to select the desired mode from Thermal (infrared image), Digital (visual light image), and Fusion (image blending).
5. Press the SET button to apply the current mode.
6. Press the back button to exit.

Note: If Fusion is selected, users can press the left/right button to select the desired blending ratio from 0% (pure visual light image), 25%, 50%, 75%, and 100% (pure infrared image) under the thermal imaging page.

5.5 Settings

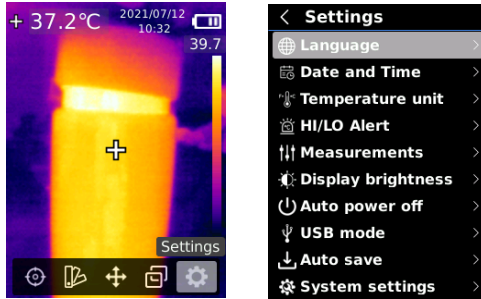

To enter Settings menu:

1. Press the SET button to open the main menu.
2. Press the left/right button to select the  option.
3. Press the SET button to enter the Settings menu.

5.5.1 Language



To set language:

1. Press the up/down button to select the Language option in the Settings menu.
2. Press the SET button to enter the Language submenu.
3. Press the up/down button to select Chinese or English.
4. Press the SET button to confirm.
5. Press the back button to exit.

5.5.2 Date and Time

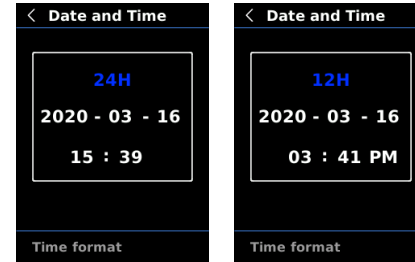

To set date and time:

1. Press the up/down button to select the Date and Time option in the settings menu.
2. Press the SET button to enter the Date and Time submenu.
3. Press the left/right button to select the parameter to be adjusted.
4. Press the SET button to enter the parameter adjustment state.
5. Press the up/down button to increase or decrease the value.
6. Press the SET button to save the settings and return to set other parameters.
7. Press the back button to exit.

5.5.3 Temperature Unit

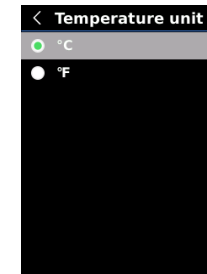

To set temperature unit:

1. Press the up/down button to select the Temperature Unit option in the Settings menu.
2. Press the SET button to enter the Temperature Unit submenu.
3. Press the up/down button to select °C or °F.
4. Press the SET button to confirm.
5. Press the back button to exit.

5.5.4 HI/LO Alert

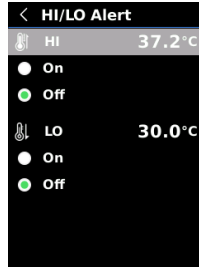

To set high/low temperature alert:

1. Press the up/down button to select the HI/LO Alert option in the Settings menu.
2. Press the SET button to enter the HI/LO Alert submenu.
3. Press the up/down button to select the desired option.
4. Select HI or LO to adjust the temperature parameter.
5. Select other options to turn the alert on or off.
6. Press the back button to exit.

5.5.5 Measurements



To set measurement parameters:

1. Press the up/down button to select the Measurements option in the Settings menu.
2. Press the SET button to enter the Measurements submenu.
3. Press the up/down button to select Emissivity.
4. Press the SET button to enter the parameter adjustment state.
5. Press the up/down button to increase or decrease the value.
6. Press the SET button to save the current setting.
7. Press the back button to exit.

Note: For emissivity values of common materials, please refer to the Common Emissivity.

5.5.6 Display Brightness

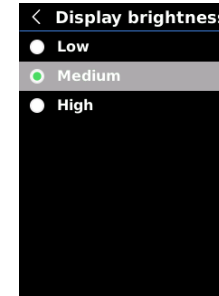

To set display brightness:

1. Press the up/down button to select the Display Brightness option in the Settings menu.
2. Press the SET button to enter the Display Brightness submenu.
3. Press the up/down button to select the desired brightness level from Low, Medium, and High.
4. Press the SET button to confirm.
5. Press the back button to exit.

5.5.7 Auto Power Off

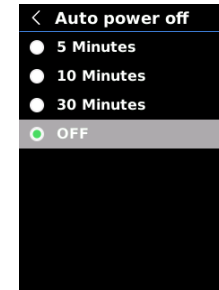

To set auto power off:

1. Press the up/down button to select the Auto Power Off option in the Settings menu.
2. Press the SET button to enter the Auto Power Off submenu.
3. Press the up/down button to select the desired option from 5 Minutes, 10 Minutes, 30 Minutes, and Off.
4. Press the SET button to confirm.
5. Press the back button to exit.

5.5.8 USB Mode



To set USB mode:

1. Press the up/down button to select the USB Mode option in the Settings menu.
2. Press the SET button to enter the USB Mode submenu.
3. Press the up/down button to select USB Disk or USB Camera.
4. Press the SET button to confirm.
5. Press the back button to exit.

Note: USB disk mode allows users to browse pictures and analyze data on a PC, while USB camera mode allows users to realize real-time image projection after connecting to a PC.

5.5.9 Auto Save



To set auto save:

1. Press the up/down button to select the Auto Save option in the Settings menu.
2. Press the SET button to enter the Auto Save submenu.
3. Press the up/down button to select Yes or No.
4. Press the SET button to confirm.
5. Press the back button to exit.

Note: Do not remove or insert the SD card in saving pictures. It is recommended to save no more than 1000 pictures, so as not to affect the response speed of the product. When the number of pictures exceeds 1,000, please clean up the SD card in time.

5.5.10 System Settings



To enter System Settings submenu:

1. Press the up/down button to select the System Settings option in the Settings menu.
2. Press the SET button to enter the System Settings submenu.

Device Information



To view the device information:

1. Press the up/down button to select the Device Information option in the System Settings submenu.
2. Press the SET button to view the detail information of the device.
3. Press the back button to exit.

Note: Capacity is the storage capacity of the SD card in use currently.

Factory Reset



To restore factory settings:

1. Press the up/down button to select the Factory Reset option in the System Settings submenu.
2. Press the SET button to enter.
3. Press the up/down button to select Yes.
4. Press the SET button to confirm.
5. Press the back button to exit.

Note: During the factory reset process, please do not force other operation to avoid program errors.

Format SD Card



To format SD card:

1. Press the up/down button to select the Format SD Card option in the System Settings submenu.
2. Press the SET button to enter.
3. Press the up/down button to select Yes.
4. Press the SET button to confirm.
5. Press the back button to exit.

Note: When formatting the SD card, please do not remove it or perform other operation to avoid program errors.

6. Operating Instructions

6.1 Image Capture

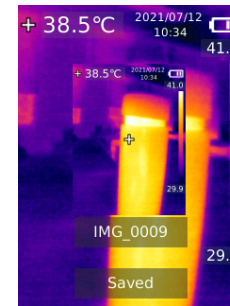

1. Pull and release the trigger to capture an image.
2. In the manual save mode, pull and release the trigger again to save the image. Or press the left/right button to discard or save the image, and press the SET button to confirm or the back button to return.
3. In the auto save mode, the image will be saved automatically.

Note: Images can only be saved if an SD card is installed.

6.2 Image Viewing

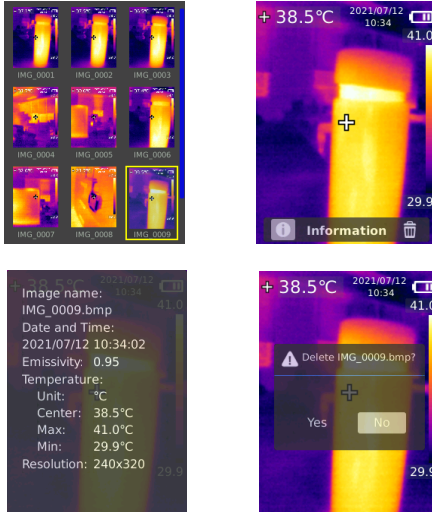

1. Press the replay button to enter the gallery interface.
2. Use the up/down/left/right button to select the desired image.
3. Press the SET button to view the image in full screen mode.
4. Press the SET button in full screen mode to delete the image or view its information, press left/right button to switch images.

Note: Do not remove or insert the SD card in viewing images.

6.3 Flashlight/Warning Light

Press and hold the flashlight button for 3 seconds to turn on/off the LED light. When the high temperature alert is on and the measured temperature exceeds the set temperature range, the LED light will flash.

Note: When the flashlight is on, please do not point to the eyes of people or animals.

6.4 USB Communication and Image Projection

1. Download and install the PC software (refer to UNI-T Documents Download Operation Guide).
2. Connect the USB cable to the PC.
3. Set the USB mode to USB Disk to browse pictures and analyze data through the PC software; set the USB mode to USB Camera to realize real-time image projection through the PC software.
4. Regarding the usage of the PC software, retrieve the Software User Manual from the Help option of the operation interface.

Note: Please do not unplug the USB cable during image projection; after use, please close the PC software before unplugging the USB cable.

6.5 SD Card

This device supports Micro SD card (TF card) to store images. To avoid affecting the operating speed of the device, please copy the backup data regularly and clean up the SD card in time. To avoid causing abnormal data on the SD card, do not insert or remove the SD card repeatedly. Try to remove and insert the SD card when the device is turned off.

6.6 Charging

Please use a safety-certified 5V/1A or 5V/2A power adapter for charging. Do not turn off the product easily during charging. If shutdown or restart is needed, please unplug the Type-C power cord and disconnect the power supply first.

7. Specifications

Sensor	UFPA
Temperature range	-10°C~400°C
Measurement resolution	0.1°C
Accuracy	0°C above target temperature, +/-2°C or +/-2%, normal temperature 25°C environment
Optimal measuring distance	1 meter
Response time	≤500ms
IR resolution	19,200 pixels (160 × 120)
Pixel size	12μm
Color palette	Iron, Rainbow, white Hot, Red Hot, Black Hot, Lava, Rainbow HC
Infrared spectral band	8μm~14μm
Field of view (FOV)	56° (H) × 42° (V)
Spatial resolution (IFOV)	6mrad
Thermal sensitivity (NETD)	<50mK
Frame rate	<9Hz
Temperature measurement display	Center point temperature, high temperature tracking (default)
Image format	BMP
Image mode	Thermal, Digital (visual light image), Fusion
Point temperature measurement	In addition to the center point, 3 points can be added.
Certifications	-CE (EN 61326-1:2013, EN 61326-2-2:2013, EN 61326-2-3) -RoHS

Visual light camera	Yes
Visual light resolution	640 x 480 pixels
Image blending ratio	0% (pure visual light image), 25%, 50%, 75%, and 100% (pure infrared image)
PC software	Yes
Real-time image transmission	Yes (real-time image projection through PC software)
Data transmission	Type-C USB interface
Product size (L x W x H)	236mm x 75.5mm x 86mm
Display type	2.8" TFT LCD
Display resolution	320 × 240 pixels
Battery	3.6V/5000mAh rechargeable Li-ion battery
Auto power off	5 minutes, 10 minutes, 30 minutes, off (default: 30 minutes)
Battery life	≥6 hours
Charging time	≤5 hours
Charging voltage/current	5V/2A
Image storage	Micro SD card
Transportation/ Storage environment	-20°C~60°C (-4°F~140°F), <85% RH (non-condensing)
Operating environment	0°C~50°C (32°F~122°F), 10%~95%RH (non-condensing)
Operating altitude	≤2000m
Standard accessories	User manual, USB cable, 16GB Micro SD card

8. Maintenance

Use a wet cloth or weak soap solution to clean the outer shell of the device. Do not use abrasives, isopropyl alcohol or solvents to clean the outer shell, lens or window.

9. Common Emissivity

Material	Emissivity	Material	Emissivity
Wood	0.85	Black paper	0.86
Water	0.96	Polycarbonate	0.8
Brick	0.75	Concrete	0.97
Stainless steel	0.14	Copper oxide	0.78
Tape	0.96	Cast iron	0.81
Aluminum plate	0.09	Rust	0.8
Copper plate	0.06	Gypsum	0.75
Black aluminum	0.95	Paint	0.9
Human skin	0.98	Rubber	0.95
Asphalt	0.96	Soil	0.93
PVC	0.93		

Note: This manual can be downloaded from the official website of Uni-Trend (refer to UNI-T Documents Download Operation Guide).

UNI-T®

UNI-TREND TECHNOLOGY (CHINA) CO., LTD.

No. 6, Gong Ye Bei 1st Road,
Songshan Lake National High-Tech Industrial
Development Zone, Dongguan City,
Guangdong Province, China

彩盒 菲林做货要求

序号	项目	内容	备注
1	尺寸	110*150mm	
2	材质	封面128双铜+内页60g双铜	
3	颜色	四色	
4	外观要求	完整清晰、版面整洁，无斑墨、残损、毛边、刀线错位等缺陷。	
5	装订方式	骑马钉	
6	表面处理		
7	其它	无	
版本		REV. 0	
DWH 设计	宣浩	MODEL 机型: UTi165B	Part NO. 物料编号: 110401110261X
CHK 审核		 优利德科技(中国)有限公司 UNI-TREND TECHNOLOGY (CHINA) LIMITED	
APPRO. 批准			